

LIFEPO4 BATTERY RACK MOUNTED USER MANUAL

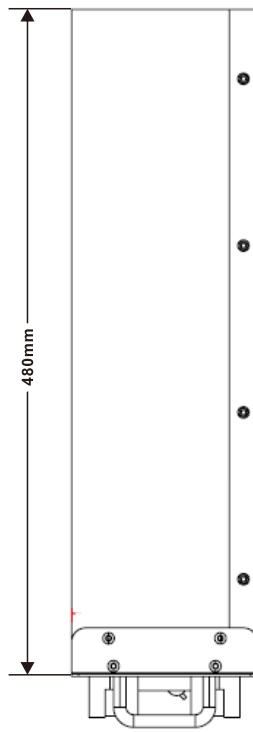

Backup Power for when the lights go out!

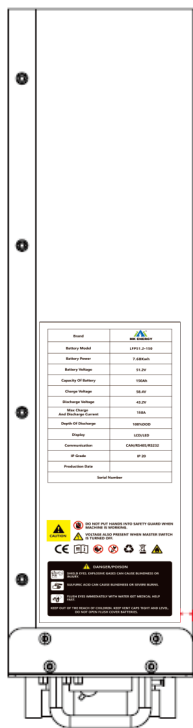
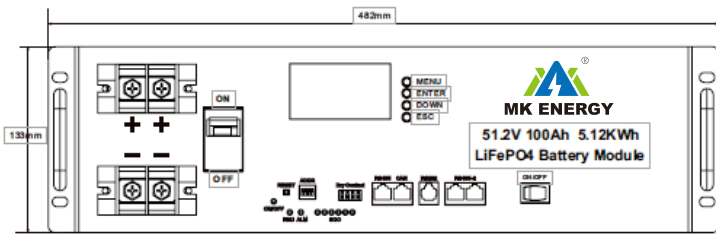

IMPORTANT SAFETY INSTRUCTIONS, PRECAUTIONS



ATTENTION!

1. It is important and necessary to read this user manual (attachment) carefully before installing or using the battery. The safety precautions mentioned in this manual do not represent all safety matters to be considered and only serve to complement standard safety precautions.
2. When installing, operating, and maintaining equipment, local safety and installation regulations shall be observed.
3. Do not wear any conductive objects such as watches, bracelets, bracelets, and rings when installing, operating and maintaining equipment.
4. If the battery must be stored for an extended period of time, it needs to be charged and discharged every six months, and the battery state of charge shall not be less than 70%.
5. After the battery is fully discharged, it should be charged within 12 hours.
6. Before maintenance, batteries and equipment need to be switched off and isolated.
7. Do not use cleaning solvents to clean batteries.
8. Do not expose batteries to flammable or corrosive chemicals or vapors.
9. Do not connect cells directly to photovoltaic (solar) panel wiring.
10. Our company is not responsible for any loss caused by violation of the requirements for general safe operation or violation of design, production, and use of equipment safety standards.

1.1 BEFORE INSTALLATION



WARNING

- 1.1.1 After unpacking, please check the product and packing list first, if the product is damaged or missing parts, please contact the local retailer.
- 1.1.2 Before installation, cut off the power supply and ensure that the battery is switched off.
- 1.1.3 Wiring must be correct, do not reverse positive and negative cables, and ensure that external devices are not short-circuited.
- 1.1.4 Direct connection of batteries and AC power is prohibited.
- 1.1.5 The battery management system is designed for 48VDC, Batteries must not be connected in series.
- 1.1.6 Please ensure that the electrical parameters of the battery system are compatible with the connected equipment.
- 1.1.7 Do not expose the battery to open flames or moisture.

1.2. USE

- 1.2.1 If the battery system needs to be moved or repaired, the power must be cut off and the battery completely switched off.
- 1.2.2 Batteries can only be connected to batteries of the same make and model.
- 1.2.3 Batteries must never be connected to faulty or incompatible devices.
- 1.2.4 If a fire occurs, only dry powder fire extinguishers can be used, liquid fire extinguishers are prohibited.
- 1.2.5 To avoid personal injury, users should not disassemble the battery by themselves. For maintenance, please contact professional maintenance personnel.

2. INTRODUCTION

This rack mounted energy storage battery can be used in photovoltaic energy storage systems or backup systems. The built-in BMS battery management system manages the battery parameters to protect equipment and ensure the longevity of the battery. Multiple battery packs can be connected in parallel to expand capacity and power to match the user's application.

3. FEATURES & BENEFITES

- Safety: the core cathode material of the battery module is made of LiFePO₄, for good safety, performance and long service life.
- Protection function: The battery management system can protect the battery module against over discharge, over charge, over current and high / low temperature.
- Balancing function: The battery management system incorporates passive cell balancing.
- Expansion: Flexible configuration, multiple battery modules can be connected in parallel to match different standby time requirements.
- Low power consumption: When no live equipment is connected, the battery can enter a low power state automatically and reduce self-discharge.
- No memory: No memory effect, shallow charge and discharge performance is excellent.

4. PARAMETER SPECIFICATION

Model	LFP51.2-200	LFP51.2-100
Nominal voltage	51.2VDC	51.2VDC
Nominal capacity	200Ah (10240wh)	100Ah (5120wh)
Dimensions (mm)	482 (442) ×620×182	482 (442) ×480×133
Weight	About 80KG	About 44KG
Working voltage	43.2-58.4V	43.2-58.4V
Charging voltage	58.4V	58.4V
Standard charging current	20A	
Max. cont. charging current	50A	
Standard discharge current	33A	
Max. cont. discharge current	100A	
Charging ambient temperature	0~50°C	
Discharge ambient temperature	-20~60°C	
Storage ambient temperature	0~60°C	
Working environment	Humidity: ≤95; Altitude: ≤4000	
Communication ports	RS232、RS485、CAN	
Power display mode	LED light /display screen	

5. INTERFACE DEFINITION & DESCRIPTION

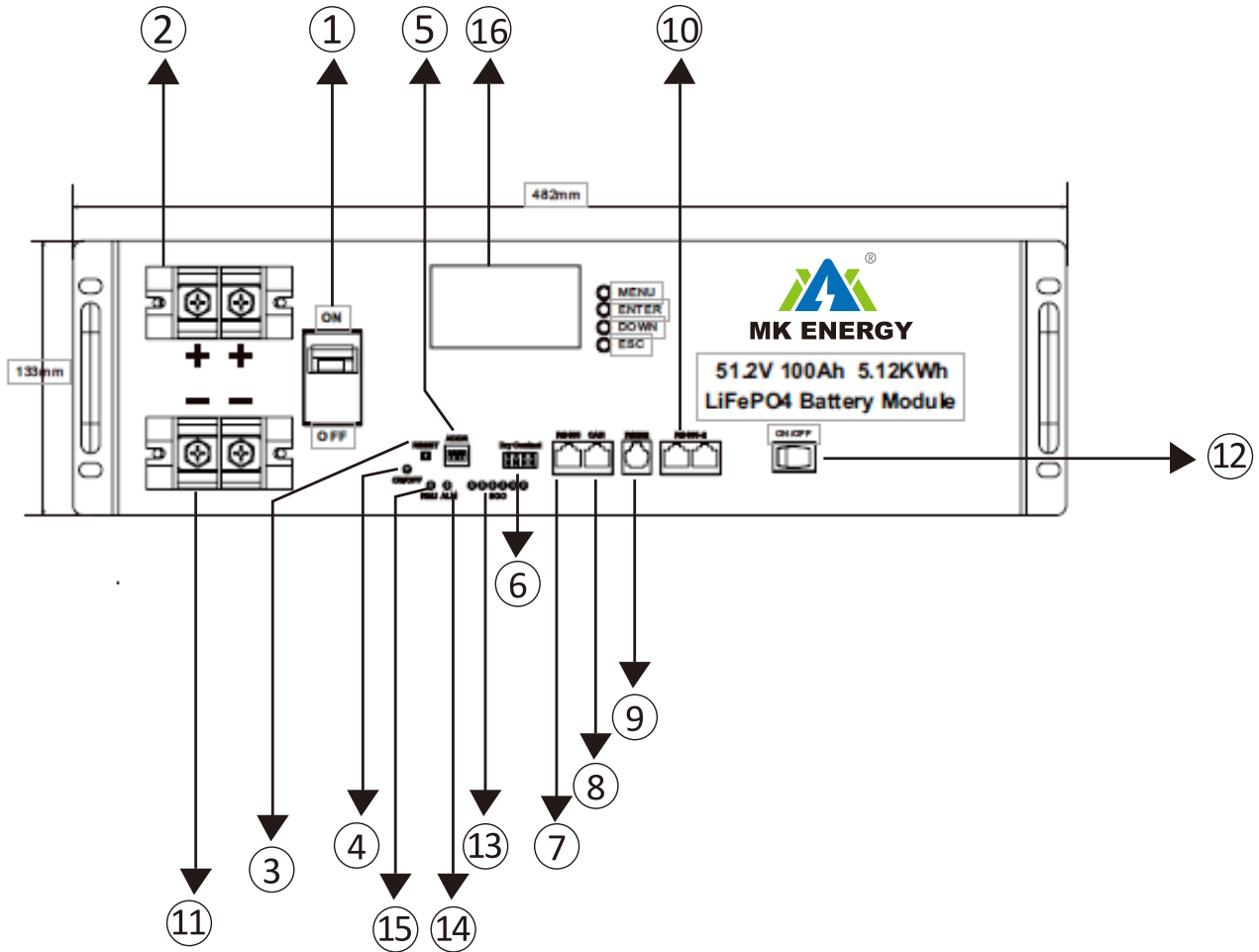

1	Battery switch	2	Positive terminal
3	BMS working indicator light	4	Reset Switch
5	Address setting DIP switch	6	DRY CONTACT
7	RS485-1 - Inverter communication port	8	CAN - Inverter communication port
9	RS232 - Host computer communication	10	RS485-Parallel communication port
11	Negative Terminal	12	Power switch
13	Battery Status indicator	14	Alarm indicator light
15	Operation indicator (Run)	16	LCD

5.1 TO RESET THE SWITCH

- When the BMS is dormant, press the button for 3 seconds and release. The protection board is activated, and the LED indicator lights up for 0.5 seconds from the RUN LED.
- When the BMS is active, press the button for 3 seconds and release, the protection board is switched off, and the LED indicator lights up for 0.5 seconds from the lowest state of charge indicator LED.
- When the BMS is active, press the button for 6S and release, the protection board is reset, and the LED lights are lit for 1.5 seconds at the same time.
- After the BMS is reset, the parameters and functions set through the host computer are still retained. Reset to factory parameters can be achieved through the management software on the host computer. The relevant running records and storage data remain unchanged (such as Energy throughput, cycle times, protection records, etc.).

5.2 RS485-1

RS485 interface, with the default baud rate of 9600, is used for external communication of battery pack, such as inverter communication.

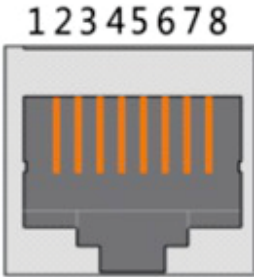
RJ45 Interface (8P8C)	PIN	Definition Description
	PIN 1	RS485-B1
	PIN 2	RS485-A1
	PIN 3	RS485-GND
	PIN 4	
	PIN 5	
	PIN 6	RS485-GND
	PIN 7	RS485-A1
	PIN 8	RS485-B1

5.2 CAN

CAN interface is used for external communication of battery pack, such as inverter communication.

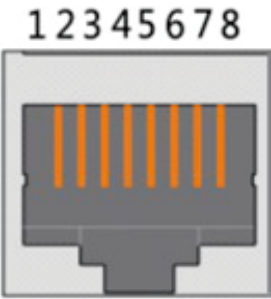
RJ45 Interface (8P8C)	PIN	Definition Description
	PIN 1	
	PIN 2	
	PIN 3	
	PIN 4	CAN L
	PIN 5	CAN H
	PIN 6	
	PIN 7	CAN GND
	PIN 8	

5.3 RS485-2

Dual RS485 interface, default baud rate 9600, parallel communication port of battery pack

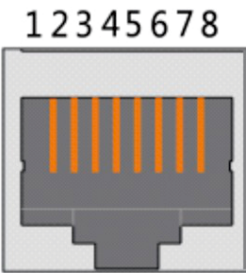
RJ45 Interface (8P8C)	PIN	Definition Description
	PIN 1	RS485-B2
	PIN 2	RS485-A2
	PIN 3	RS485-GND
	PIN 4	
	PIN 5	
	PIN 6	RS485-GND
	PIN 7	RS485-A2
	PIN 8	RS485-B2

5.4 RS232

Default baud rate bps .9600. Used for communication with the host computer.

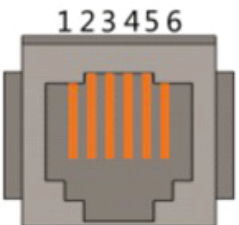
RJ12 Interface (6P6C)	PIN	Definition Description
	PIN 1	NC
	PIN 2	NC
	PIN 3	TX
	PIN 4	RX
	PIN 5	GND
	PIN 6	NC

5.5 ADDRESS SETTING DIP SWITCH

Used to determine different communication addresses. The lower position is “off”, which means “0”, and the upper position is “on”, which means “1”. When the battery packs are connected in parallel, different addresses can be set using the DIP switches starting with the first battery.

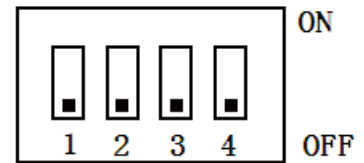

ADDRESS	DIAL SWITCH POSITION			
	#1	#2	#3	#4
0	OFF	OFF	OFF	OFF
1	ON	OFF	OFF	OFF
2	OFF	ON	OFF	OFF
3	ON	ON	OFF	OFF
4	OFF	OFF	ON	OFF
5	ON	OFF	ON	OFF
6	OFF	ON	ON	OFF
7	ON	ON	ON	OFF
8	OFF	OFF	OFF	ON
9	ON	OFF	OFF	ON
10	OFF	ON	OFF	ON
11	ON	ON	OFF	ON
12	OFF	OFF	ON	ON
13	ON	OFF	ON	ON
14	OFF	ON	ON	ON
15	ON	ON	ON	ON

5.6 BATTERY STATUS INDICATOR

TABLE 1 – LED WORKING STATUS INDICATORS

State	Normal/alert/protection	RUN	ALM	Electricity indicator LED				Note
		●	●	●	●	●	●	
Shutdown	Sleep	OFF	OFF	OFF	OFF	OFF	OFF	Battery is off
Standby	Normal	Flash 1	OFF	According to State of Charge				Standby status
	Alarm	Flash 1	Flash 3					Module Low Voltage
Charge	Normal	ON	OFF	According to State of Charge				Maximum power LED flash (flash 2), Overcharge alarm ALM no flicker
	Alarm	ON	Flash 3					
	Overcharge protection	ON	OFF	ON	ON	ON	ON	If there is no electricity, the indicator is in standby state
	Temperature, overcurrent, failure protection	OFF	ON	OFF	OFF	OFF	OFF	Stop charging
Discharge	Normal	Flash 3	OFF	According to State of Charge				
	Alarm	Flash 3	Flash 3					
	Undercurrent protection	OFF	OFF	OFF	OFF	OFF	OFF	Stop discharge
	Temperature, overcurrent, short circuit, reverse connection, failure protection	OFF	ON	OFF	OFF	OFF	OFF	Stop discharge
Failure		OFF	ON	OFF	OFF	OFF	OFF	Stop charging and discharging

TABLE 2 – DESCRIPTION OF CAPACITY INDICATION

State		Charge				Discharge			
Capacity indicator		L4●	L3●	L2●	L1●	L4●	L3●	L2●	L1●
Electricity (%)	0-25%	OFF	OFF	OFF	Flash 2	OFF	OFF	OFF	ON
	25-50%	OFF	OFF	Flash 2	ON	OFF	OFF	ON	ON
	50-75%	OFF	Flash 2	ON	ON	OFF	ON	ON	ON
	75-100%	Flash 2	ON	ON	ON	ON	ON	ON	ON
● running indicator		Always bright				Flash (flash 3)			

6. INSTALLATION & OPERATION GUIDELINES

APPLICATION SCHEMATIC

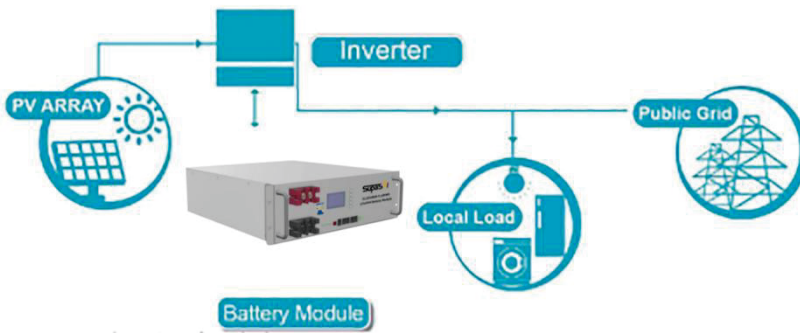

PARALLEL CONNECTION OF BATTERY PACK

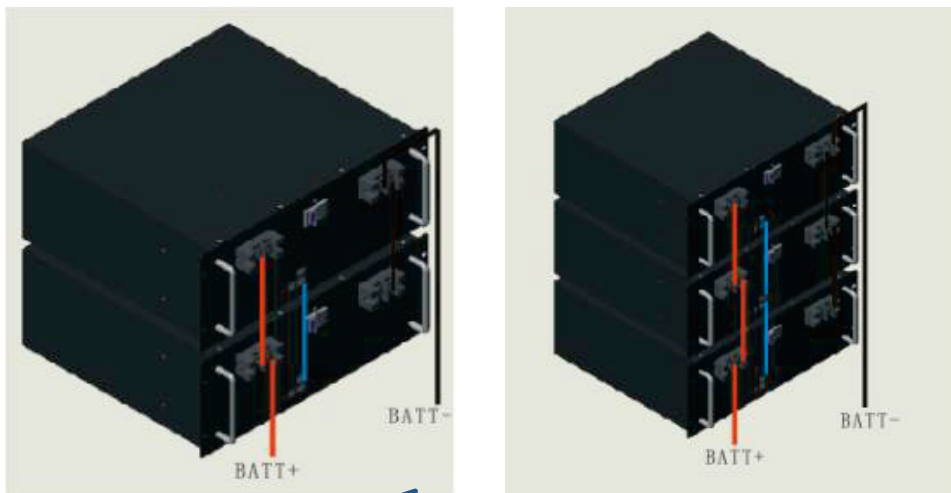

Note: when connecting the equipment, the battery output positive and negative electrodes should be taken from the first group and the last group of batteries,

6.3 COMMUNICATION CONNECTION

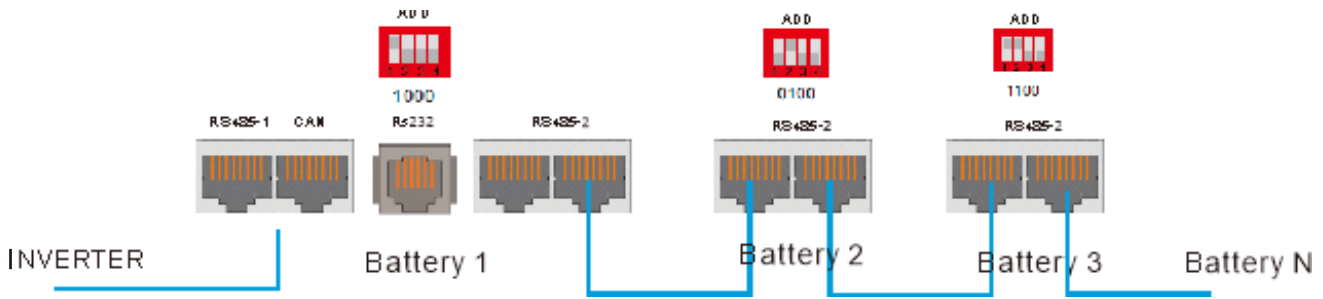

6.4 OPERATING TOOLS

Use insulated tools to prevent accidental electric shock or short circuit.



Nippers



Network crimping pliers



Screwdriver

6.5 SAFETY EQUIPMENT

When connecting and handling the battery pack, it is recommended to wear the following safety equipment.



Insulating gloves





Goggles



Protective shoes

7. INSTALLATION

INSTALLATION ACCESSORIES

Picture	Description	Quantity
	Battery cable(black)	1pcs
	Battery cable(red)	1pcs
	BMS cable	1pcs

7.2 RACK MOUNTED INSTALLATION INSTRUCTIONS

Use insulated tools to prevent accidental electric shock or short circuit.



Note: Use Caution when installing or removing battery from the rack, be careful not to drop it or bump it

7.3 INSTALLATION PRECAUTIONS

Ensure that the installation location meets the following conditions:

- The area is completely waterproof.
- The floor is flat.
- No flammable and explosive items.
- Ambient temperature is between 0°C and 50°C, the temperature and humidity remain constant.
- This area has little dust and dirt.

8. MAINTENANCE PRECAUTIONS



ATTENTION!

If the ambient temperature is out of the working range, the battery pack will stop working. The optimal operating temperature of the battery pack ranges from 0 to 50 degrees Celsius. If the battery pack is constantly exposed to harsh temperatures, it may affect battery pack performance and lifetime.

Because of its maintenance-free characteristics, Periodic maintenance periods can be extended. The following checks must be carried out at least every three months.

- Check whether the terminals of lithium iron phosphate battery are loose, damaged, deformed or corroded, and whether the battery shell is damaged or deformed.
- Observe the state of the battery pack indicator LEDs. Refer to the table above for explanation of the status indications.
- When there is a failure, the red ALM LED light will be flashing. Refer to the table above for explanation of the status indications. Then press the RST reset key to see if the alarm is cleared. After the battery restarts, if the alarm is not cleared, please contact the manufacturer to assist, do not open the battery housing.
- For a multi-pack parallel application scenario, if one of the packs needs to be replaced, make sure that the voltage difference between the newly replaced battery pack and the other battery packs in the parallel system is within 2V.

9. TROUBLESHOOTING

9.1 UNDERVOLTAGE ALARM

Failure Mode: ALM alarm indicator lights flicker, RUN operation indicator is off.

Cause analysis:

- (1) Battery is over discharged
- (2) BMS failure.

Solution: Charge the battery. BMS will reconnect when charging voltage is applied to the battery. If the BMS has failed, please contact the manufacturer.

9.2 DISCHARGE OVERCURRENT PROTECTION

Failure Mode: ALM alarm indicator lights flicker, RUN operation indicator is off.

Cause analysis:

- (1) The load current has exceeded the battery discharge protection value.
- (2) BMS failure.

Solution: Reduce the load and reset the battery. If the BMS has failed, please contact the manufacturer.

9.3 TEMPERATURE PROTECTION

Failure Mode: ALM alarm indicator lights flicker, RUN operation indicator is off.

Cause analysis: Ambient temperature may be too high or too low.

Solution: When the battery temperature returns to normal, the BMS recovers from the temperature protection state and the red indicator lamp goes out.

9.4 BATTERY NO VOLTAGE OUTPUT

Failure Mode: the power indicator LED turns off, the voltage at terminals is measured 0V.

Cause analysis: The battery is not activated, or the battery management system is abnormal.

Solution: Activate the battery or reset the battery through the reset key on the battery panel. If there there is still no voltage output, contact the manufacturer for assistance.

10. APPENDIX 1 COMMUNICATION WIRE

10.1 DEFINITION OF RS485 COMMUNICATION PORT OF BATTERY PACK.

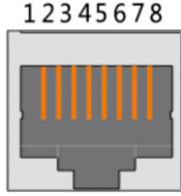
RJ45 Interface (8P8C)	PIN	Definition description
	PIN 1	RS485-B1
	PIN 2	RS485-A1
	PIN 3	RS485-GND
	PIN 4	RS485-B1
	PIN 5	RS485-A1
	PIN 6	RS485-GND
	PIN 7	NC
	PIN 8	NC

10.2 DEFINITION OF CAN COMMUNICATION PORT OF BATTERY PACK.

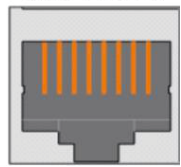
RJ45 Interface (8P8C)	PIN	Definition description
	PIN 1	CAN-L
	PIN 2	CAN-GND
	PIN 3	NC
	PIN 4	CAN-H
	PIN 5	CAN-L
	PIN 6	NC
	PIN 7	CAN-GND
	PIN 8	CAN-H

10.3 SCHEMATIC DIAGRAM OF COMMUNICATION LINE BETWEEN BATTERY PACK AND INVERTER.

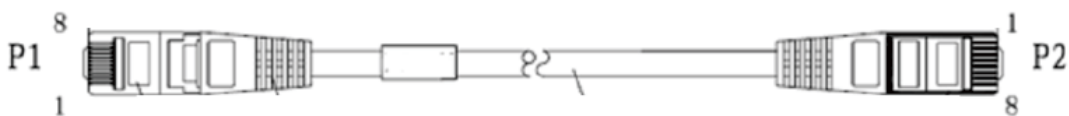

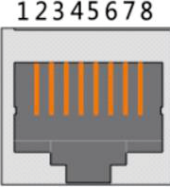
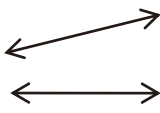

11. CAN COMMUNICATION CONNECTION WIRE SEQUENCE BETWEEN BATTERY PACK AND INVERTER.

11.1 COMMUNICATION CONNECTION WITH SOROTEC INVERTER.

RJ45 Interface (8P8C)	PIN	Line color	Definition description	Connection sequence	SOROTEC INVERTER
	PIN 1	White orange	CAN-L		RS232 -RXD
	PIN 2	Orange	CAN-GND		RS232 -TXD
	PIN 3	White green	NC		CAN-H
	PIN 4	Blue	CAN-H		NC
	PIN 5	White blue	CAN-L		CAH-L
	PIN 6	Green	NC		RS485 -B
	PIN 7	White brown	CAN-GND		RS485 -A
	PIN 8	Brown	CAN-H		GND

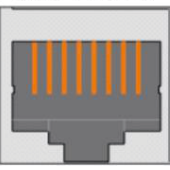
11.2 COMMUNICATION CONNECTION WITH VICTRON INVERTER.

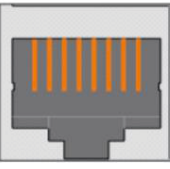
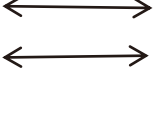

RJ45 Interface (8P8C)	PIN	Line color	Definition description	Connection sequence	VICTRON INVERTER
	PIN 1	White orange	CAN-L		NC
	PIN 2	Orange	CAN-GND		NC
	PIN 3	White green	NC		GND
	PIN 4	Blue	CAN-H		NC
	PIN 5	White blue	CAN-L		NC
	PIN 6	Green	NC		NC
	PIN 7	White brown	CAN-GND		CAN-H
	PIN 8	Brown	CAN-H		CAH-L

11.3 COMMUNICATION CONNECTION WITH DEYE INVERTER.

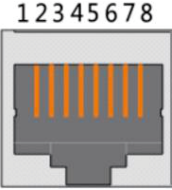

RJ45 Interface (8P8C)	PIN	Line color	Definition description	Connection sequence	DEYE INVERTER
	PIN 1	White orange	CAN-L		NC
	PIN 2	Orange	CAN-GND		NC
	PIN 3	White green	NC		GND
	PIN 4	Blue	CAN-H		CAN-H
	PIN 5	White blue	CAN-L		CAH-L
	PIN 6	Green	NC		NC
	PIN 7	White brown	CAN-GND		NC
	PIN 8	Brown	CAN-H		NC

11. CAN COMMUNICATION CONNECTION WIRE SEQUENCE BETWEEN BATTERY PACK AND INVERTER.

11.4 COMMUNICATION CONNECTION WITH GROWATT INVERTER.

RJ45 Interface (8P8C)	PIN	Line color	Definition description	Connection sequence	Growatt INVERTER
	PIN 1	White orange	CAN-L		NC
	PIN 2	Orange	CAN-GND		NC
	PIN 3	White green	NC		NC
	PIN 4	Blue	CAN-H		CAN-H
	PIN 5	White blue	CAN-L		CAH-L
	PIN 6	Green	NC		NC
	PIN 7	White brown	CAN-GND		NC
	PIN 8	Brown	CAN-H		NC

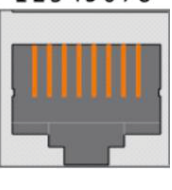
11.5 COMMUNICATION CONNECTION WITH MUST INVERTER.

RJ45 Interface (8P8C)	PIN	Line color	Definition description	Connection sequence	MUST INVERTER
	PIN 1	White orange	CAN-L		RS485 -B
	PIN 2	Orange	CAN-GND		RS485 -A
	PIN 3	White green	NC		NC
	PIN 4	Blue	CAN-H		NC
	PIN 5	White blue	CAN-L		CAH-L
	PIN 6	Green	NC		CAN-H
	PIN 7	White brown	CAN-GND		NC
	PIN 8	Brown	CAN-H		NC

11.6 COMMUNICATION CONNECTION WITH GOODWE INVERTER.

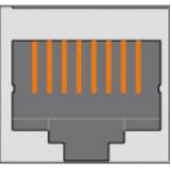
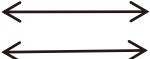
RJ45 Interface (8P8C)	PIN	Line color	Definition description	Connection sequence	GOODWE INVERTER
	PIN 1	White orange	CAN-L		NC
	PIN 2	Orange	CAN-GND		NC
	PIN 3	White green	NC		NC
	PIN 4	Blue	CAN-H		CAN-H
	PIN 5	White blue	CAN-L		CAH-L
	PIN 6	Green	NC		NC
	PIN 7	White brown	CAN-GND		NC
	PIN 8	Brown	CAN-H		NC

12. RS485 COMMUNICATION CONNECTION LINE SEQUENCE BETWEEN BATTERY PACK AND INVERTER.

12.1 COMMUNICATION CONNECTION WITH VOLTRONIC INVERTER.

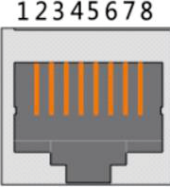
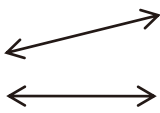
RJ45 Interface (8P8C)	PIN	Line color	Definition description	Connection sequence	Voltronic INVERTER
	PIN 1	White orange	RS485 -B1		RS232 -TX
	PIN 2	Orange	RS485 -A1		RS232 -RX
	PIN 3	White green	RS485 -GND		RS485 -B
	PIN 4	Blue	RS485 -B1		NC
	PIN 5	White blue	RS485 -A1		RS485 -A
	PIN 6	Green	RS485 -GND		CAH -H
	PIN 7	White brown	NC		CAH -L
	PIN 8	Brown	NC		GND

12.2 COMMUNICATION CONNECTION WITH GROWATT INVERTER.

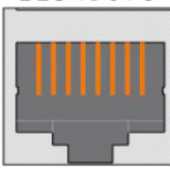
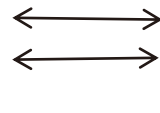
RJ45 Interface (8P8C)	PIN	Line color	Definition description	Connection sequence	Growatt INVERTER
	PIN 1	White orange	RS485 -B1		RS485 -B
	PIN 2	Orange	RS485 -A1		RS485 -A
	PIN 3	White green	RS485 -GND		NC
	PIN 4	Blue	RS485 -B1		NC
	PIN 5	White blue	RS485 -A1		NC
	PIN 6	Green	RS485 -GND		NC
	PIN 7	White brown	NC		NC
	PIN 8	Brown	NC		NC

12.3 COMMUNICATION CONNECTION WITH SRNE INVERTER.

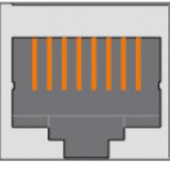
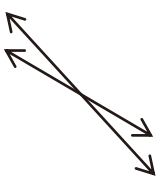
RJ45 Interface (8P8C)	PIN	Line color	Definition description	Connection sequence	SRNE INVERTER
	PIN 1	White orange	RS485 -B1		5V
	PIN 2	Orange	RS485 -A1		GND
	PIN 3	White green	RS485 -GND		NC
	PIN 4	Blue	RS485 -B1		NC
	PIN 5	White blue	RS485 -A1		NC
	PIN 6	Green	RS485 -GND		NC
	PIN 7	White brown	NC		RS485 -A2
	PIN 8	Brown	NC		RS485 -B2

12. RS485 COMMUNICATION CONNECTION LINE SEQUENCE BETWEEN BATTERY PACK AND INVERTER.

12.4 COMMUNICATION CONNECTION WITH SOROTEC INVERTER.

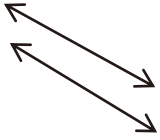
RJ45 Interface (8P8C)	PIN	Line color	Definition description	Connection sequence	SOROTEC INVERTER
	PIN 1	White orange	RS485 -B1		RS232 -RXD
	PIN 2	Orange	RS485 -A1		RS232 -TXD
	PIN 3	White green	RS485 -GND		CAN-H
	PIN 4	Blue	RS485 -B1		NC
	PIN 5	White blue	RS485 -A1		CAH-L
	PIN 6	Green	RS485 -GND		RS485 -B
	PIN 7	White brown	NC		RS485 -A
	PIN 8	Brown	NC		GND

13. APPENDIX 2 COMMUNICATION PROTOCOL.

13.1 CHOOSE COMMUNICATION PROTOCOL VIA RS485.

1. Press MENU, you can see the main interface.

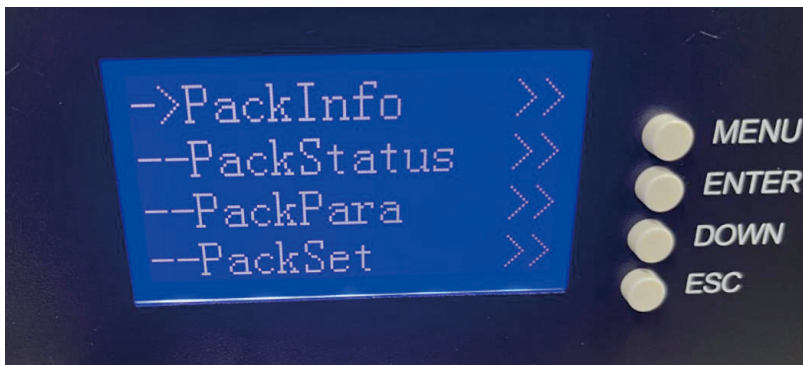

2. Press DOWN to "PackSet", then ENTER.



13. APPENDIX 2 COMMUNICATION PROTOCOL.

3. Choose RS485, then press ENTER, you can see communication protocol via RS485.

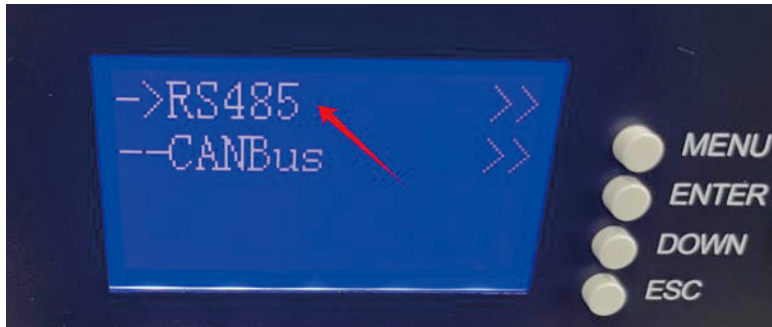

4. For example, we choose RS485-Voltronic, then press ENTER, it will be ok.

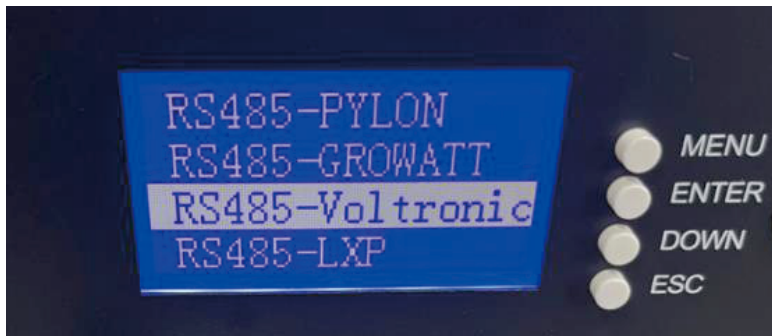

5. If you want to choose via CAN, press ESC back to step 2.





+1435 262 9595



watts247solar@gmail.com

MK ENERGY US

Email: watts247solar@gmail.com

www.mkenergy.us

Sales Center:

11690E 19000N

Mount Pleasant

84647 USA



MK ENERGY