

# User Manual

## MPPT Solar Charge Controller



# Table Of Contents

<b>Information on this Manual</b> .....	1
Validity.....	1
Scope.....	1
Target Group.....	1
Safety Instructions.....	1
<b>Introduction</b> .....	2
Features.....	2
Product Overview.....	3
<b>Installation</b> .....	4
Unpacking and Inspection.....	4
Mounting the Unit.....	4
Battery Connection.....	5
PV Connection.....	6
<b>Operation</b> .....	7
Operation and Display Panel.....	7
LCD Display Icons.....	8
LCD Setting.....	9
LCD Display Information.....	10
Fault Reference Code.....	12
Warning Indicator.....	12
<b>Trouble Shooting</b> .....	12
<b>Specifications</b> .....	13

## Information on this Manual

### Validity

- ▶ This manual is valid for the following devices:
- ▶ SC4860
- ▶ SC4880
- ▶ SC48100
- ▶ SC48120

### Scope

This manual describes the assembly, installation, operation and troubleshooting of this unit. Please read this manual carefully before installations and operations.

### Target Group

This document is intended for qualified persons and end users. Tasks that do not require any particular qualification can also be performed by end users. Qualified persons must have the following skills:

- ▶ Knowledge of how a solar charge controller works and is operated
- ▶ Training in how to deal with the dangers and risks associated with installing and using electrical devices and installations
- ▶ Training in the installation and commissioning of electrical devices and installations
- ▶ Knowledge of the applicable standards and directives
- ▶ Knowledge of and compliance with this document and all safety information

## Safety Instructions



**WARNING: This chapter contains important safety and operating instructions. Read and keep this manual for future reference.**

1. **CAUTION** – Only qualified personnel can install this device with battery.
2. Before using the unit, read all instructions and caution marks on the unit, understand the batteries and all appropriate sections of this manual.
3. **CAUTION** – To reduce risk of injury, charge only deep-cycle lead acid type rechargeable batteries. Other types of batteries may burst, causing personal injury and damage.
4. **NEVER** charge a frozen battery.
5. Do not disassemble the unit. Take it to a qualified service center when service or repair is required. Incorrect re-assembly may result in a risk of electric shock or fire.
6. To reduce risk of electric shock, disconnect all wiring before attempting any maintenance or cleaning. Turning off the unit will not reduce this risk.
7. Be very cautious when working with metal tools on or around batteries. A potential risk, such as dropping a tool to spark or short circuit batteries or other electrical parts, could cause an explosion.
8. Please strictly follow installation procedure when you want to disconnect terminals. Please refer to INSTALLATION section of this manual for the details.
9. **Warning!!** Only qualified service persons are able to service this device. If errors still persist after following troubleshooting table, please send this solar charge controller back to local dealer or service center for maintenance.

## Introduction

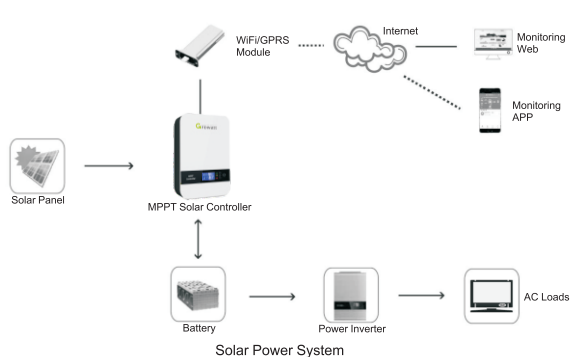

This MPPT solar controller is an advanced maximum power point tracking solar battery charger. The controller features a smart tracking algorithm that finds and maintains operation at the solar array peak power point, maximizing energy converting efficiency.

The MPPT solar controller charging process has been optimized for long battery life and improved system performance. Self-diagnostics and electronic error protections prevent damage when installation mistakes or system faults occur. The WiFi / GPRS module is a plug-and-play monitoring device to be installed on the controller. With this device, users can monitor the status of the PV system from the mobile phone or from the website anytime anywhere.

## Features

- ▶ 12V/24V/48V auto work, parallel design
- ▶ Multi-stage charging optimizes battery performance
- ▶ MPPT tracking efficiency >99.5%, peak conversion efficiency 98%
- ▶ Compatible with gel, AGM flooded, sealed lead acid and lithium battery
- ▶ Comprehensive protection
- ▶ WiFi/GPRS Monitoring(optional)
- ▶ BMS (optional)

## Product Overview

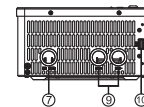
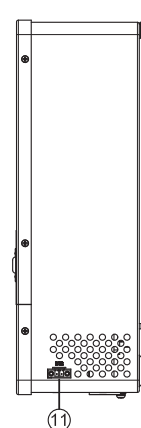
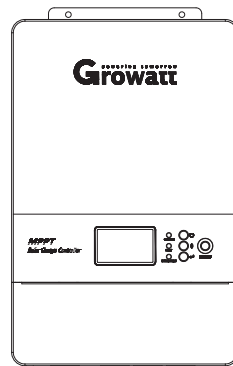

(SC4860/SC4880)

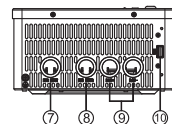

(SC48100/SC48120)

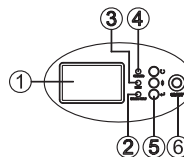

- |                       |                                  |
|-----------------------|----------------------------------|
| 1. LCD Display        | 7. PV1± input                    |
| 2. Warning indicator  | 8. PV2± input                    |
| 3. Fault indicator    | 9. Battery input                 |
| 4. Charging indicator | 10. WiFi/GPRS communication port |
| 5. Function buttons   | 11. BTS                          |
| 6. On/Off switch      |                                  |

# Installation

## Unpacking and Inspection

Before installation, please inspect the unit. Be sure that nothing inside the package is damaged. You should have received the following items in the package:

- ▶ The unit x1
- ▶ User manual x1
- ▶ BTS temperature control wire(optional)x1
- ▶ Cube WiFi/GPRS(optional)x1

## Mounting the Unit

Consider the following points before selecting where to install:

- ▶ Do not mount the controller on flammable construction materials.
- ▶ Mount on a solid surface
- ▶ Install this controller at eye level in order to allow the LCD display to be read at all times.
- ▶ The ambient temperature should be between 0°C and 55°C to ensure optimal operation.
- ▶ The recommended installation position is to be adhered to the wall vertically.
- ▶ Be sure to keep other objects and surfaces as shown in the right diagram to guarantee sufficient heat dissipation and to have enough space for removing wires.

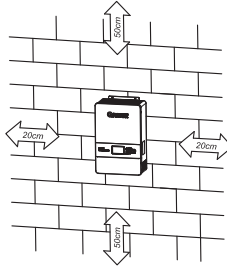

**⚠ SUITABLE FOR MOUNTING ON CONCRETE OR OTHER NON-COMBUSTIBLE SURFACE ONLY.**

## Dimensions & Structure

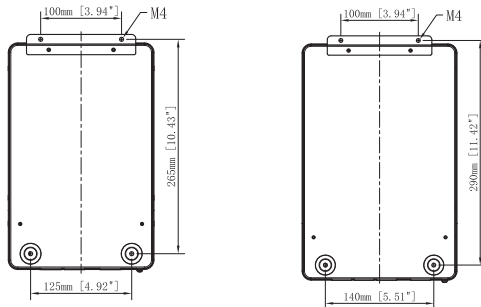

(SC4860/SC4880)

(SC48100/SC48120)

## Battery Connection

**CAUTION:** For safety operation and regulation compliance, it's requested to install a separate DC over-current protector or disconnect device between battery and controller. It may not be requested to have a disconnect device in some applications, however, it's still requested to have over-current protection installed. Please refer to typical amperage in below table as required fuse or breaker size.

**Ring terminal:**

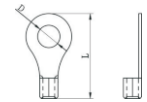

**WARNING!** All wiring must be performed by a qualified person.

**WARNING!** It's very important for system safety and efficient operation to use appropriate cable for battery connection. To reduce risk of injury, please use the proper recommended cable and terminal size as below.

Note: For the lead acid battery, the recommended charge current is 0.2C(C-battery capacity). Please follow below steps to implement lead-acid battery connection:

1. Assemble battery right terminal based on recommended battery cable and terminal size.
2. Connect all battery packs as units requires. It's suggested to connect at least 350Ah capacity battery for 48V/80 model.

Model	SC4860	SC4880	SC48100	SC48120
Capacity of battery	250Ah	350Ah	450Ah	550Ah

Insert the ring terminal of battery cable flatly into battery connector of controller and make sure the bolts are tightened with torque of 2-3Nm. Make sure polarity at both the battery and the controller is correctly connected and ring terminals are tightly screwed to the battery terminals.

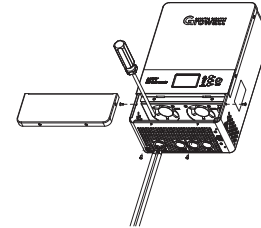

**WARNING: Shock Hazard**

Installation must be performed with care due to high battery voltage in series.



**CAUTION!** Do not place anything between the flat part of the controller terminal and the ring terminal. Otherwise, overheating may occur.

**CAUTION!** Do not apply anti-oxidant substance on the terminals before terminals are connected tightly.

**CAUTION!** Before making the final DC connection or closing DC breaker, be sure positive (+) must be connected to positive (+) and negative (-) must be connected to negative (-).

## Recommended cable size:

Model	Copper Wire Type	Recommended Size	Minimum Size
60A	Copper	5AWG	6AWG
80A	Copper	4AWG	5AWG
100A	Copper	2AWG	3AWG
120A	Copper	2AWG	2AWG

## PV Connection

**CAUTION:** Before connecting to PV modules, please install **separately** a DC circuit breaker between controller and PV modules.

**WARNING!** All wiring must be performed by a qualified personnel.

**WARNING!** It's very important for system safety and efficient operation to use appropriate cable for PV module connection. To reduce risk of injury, please use the proper recommended cable size as below.

### PV Module Selection:

When selecting proper PV modules, please be sure to consider below parameters:

1. Open circuit Voltage (Voc) of PV modules not exceeds max. PV array open circuit voltage of controller.
2. Open circuit Voltage (Voc) of PV modules should be higher than min. battery voltage.

MPPT CONTROLLER MODEL	60A/80A/100A/120A
Max. PV Array Open Circuit Voltage	150Vdc max
PV Array MPPT Voltage Range	60~145Vdc

Please follow below steps to implement PV module connection:

1. Remove insulation sleeve 10 mm for positive and negative conductors.
2. Check correct polarity of connection cable from PV modules and PV input connectors. Peel the plastic tube 10mm from the positive polarity end of the wire. Insert the wire into the ring terminal and crimp the edges by tools. Then connect the wire to the PV Input port "PV+" of the controller. Also use the same method to connect the PV Input port "PV-".

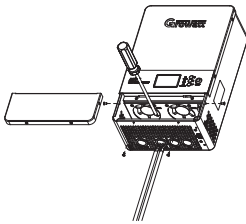

3. Make sure the wires are securely connected.

# Operation

## Operation and Display Panel

The operation and display panel, shown in below chart, is on the front panel of the controller. It includes three indicators, three function keys and a LCD display, indicating the operating status and input/output power information.

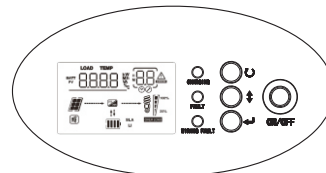

### Power ON/OFF

Press the "ON/OFF" button to turn on or turn off the system.

### LED Indicator

LED Indicator		Messages	
CHARGING	Green	Solid On	System is running fine, but not charging now
		Flashing	During charging now
FAULT	Red	Solid On	An error occurs
		Flashing	A warning occurs
WIRING FAULT	Red	Solid On	Battery wiring reversed

### Function Buttons

Button	Description
ESC	To exit setting mode
UP/DOWN	To change selection
ENTER	To confirm the selection in setting mode or enter setting mode

## LCD Display Icons

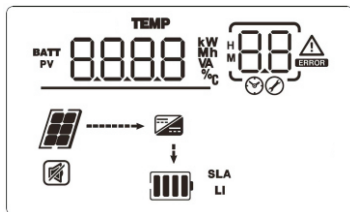

Icon	Function Description
<b>System Parameters Information</b>	
<b>BATT</b>	Indicates the battery
<b>PV</b>	Indicates the PV input
<b>TEMP</b> 8888 kW MVA %C	Indicate PV voltage, battery voltage, charging current, etc.
<b>Configuration Program and Fault Information</b>	
88	Indicates the setting programs.
88 ⚠	Warning: flashing with warning code.
88 ⚠	Fault:lighting with fault code
<b>System Status Information</b>	
	Indicates battery level by 0-24%, 25-49%, 50-74% and 75-100% in battery mode and charging status in line mode.
<b>SLA</b>	Indicates SLA battery
<b>LI</b>	Indicates Lithium battery
	Indicates unit connects to the PV panel.
	Indicates the DC/DC circuit is working.
	Indicates unit alarm is disabled.



## LCD Setting

After pressing and holding ENTER button for 3 seconds, the unit will enter setting mode. Press "UP/DOWN" button to select setting programs. And then, press "ENTER" button to confirm the selection or ESC button to exit.

Program	Description	Setting Option	
01	Maximum charging current	<b>PV</b> 80 A 01 120A model: Default 60A, 10A~120A Settable 100A model: Default 60A, 10A~100A Settable 80A model: Default 60A, 10A~80A Settable 60A model: Default 60A, 10A~60A Settable	
02	Battery type	AGM (default) AGM 02	Flooded FLD 02
		User-Defined USE 02	Lithium LI 02
		If "User-Defined" is selected, battery charge voltage and low DC cut-off voltage can be set up in program 05, 06 and 07.	
		If "LI" is selected, battery can be set as "Use-Defined". For lithium battery, program 5 and program 6 need to be set as the same value	
03	Buzzer	Buzzer on (default) BON 03	Buzzer off BOF 03
04	Backlight Control	Backlight on (default) LON 04	Backlight off LOF 04
05	Bulk charging voltage (C.V voltage)	<b>BATT</b> 56.4 v 05 48V mode: default 56.4V, 48.0V~58.4V Settable 24V mode: default 28.2V, 24.0V~29.2V Settable 12V mode: default 14.1V, 12.0V~14.6V Settable	
06	Floating charging voltage	<b>BATT</b> 54.0 v 06 48V mode: default 54.0V, 48.0V~58.4V Settable 24V mode: default 27.0V, 24.0V~29.2V Settable 12V mode: default 13.5V, 12.0V~14.6V Settable	
07	Low DC cut-off voltage	<b>BATT</b> 39.6 v 07 48V mode: default 42.0V, 40.0V~48.0V Settable 24V mode: default 21.0V, 20.0V~24.0V Settable 12V mode: default 10.5V, 10.0V~12.0V Settable	

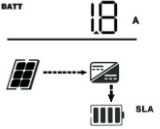
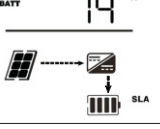
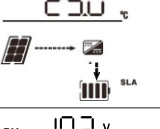

## LCD Display Information

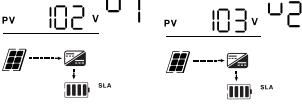
The LCD display information will be switched in turns by pressing "UP/DOWN" key. The selectable information is switched as below order.

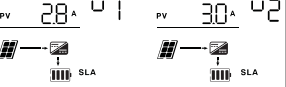
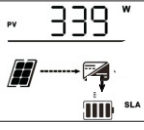
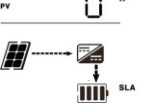
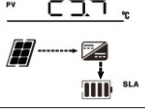



Setting Information	LCD display
Charging voltage	
Battery charging current	
Battery charging power	
Battery temperature sensor (BTS)	
PV input voltage	 <p>For SC4860 and SC4880</p>
	 <p>For SC48100 and SC48120</p>

PV generated current	 <p>For SC4860 and SC4880</p>
	 <p>For SC48100 and SC48120</p>
PV generated power	
Total PV generated energy	
PV controller temperature	

## Fault Reference Code

Fault Code	Fault Event	Icon On
01	Fan is locked when controller is off.	01 
02	Over temperature	02 
03	Battery voltage is too high	03 

## Warning Indicator

Warning Code	Warning Event	Icon Flashing
04	Battery voltage is too low	04 
06	PV input voltage is too high	06 
07	Overload	07 
10	Battery capacity is too low	10 

## Trouble Shooting

Use the table below to solve minor problems.

Problem	LCD/ LED/ Buzzer	Explanation	What to do
When power fails, the backup time is shorten.	Battery low alarm issue quickly.	Battery voltage is too low.	Charge the unit at least 8 hours.
		Battery capacity is not full even after charge the unit for at least 8 hours.	Check the date code of the battery. If the batteries are too old, replace the batteries.
No LED display on the front panel when PV/batter is working	No LED display.	Battery/PV is not connected well.	Return to repair center.
		Fault code 01	Fan fault
	Fault code 02	Internal temperature of controller component is over 90℃.	Check whether the air flow of the unit is blocked or whether the ambient temperature is too high.
	Fault code 03	Battery is over-charged. The battery voltage is too high.	Return to repair center. Check if spec and quantity of batteries are meet requirements.
	Fault code 04	The battery voltage is too low.	Connect with PV to charge, the problem will be solved.
	Fault code 06	PV input voltage is too high	Return to repair center.

If any unlisted abnormal situations occur, please call the service people for professional examination.

## Specifications

MODEL	SC4860	SC4880	SC48100	SC48120
Solar System Voltage	12V/24V/48V			
<b>Electrical</b>				
PV operating voltage	15~50Vdc@12V 30~100 Vdc@24V 60~145Vdc@48V	15~50Vdc@12V 30~100 Vdc@24V 60~145Vdc@48V	15~50Vdc@12V 30~100 Vdc@24V 60~145Vdc@48V	15~50Vdc@12V 30~100 Vdc@24V 60~145Vdc@48V
Max. PV open circuit voltage	150Vdc	150Vdc	150Vdc	150Vdc
Max. PV input power	12V 1000W	12V 1250W	12V 1500W	12V 1750W
	24V 2000W	24V 2500W	24V 3000W	24V 3500W
	48V 4000W	48V 5000W	48V 6000W	48V 7000W
Number of MPPT trackers	1	1	2	2
Max. charging current	60A	80A	100A	120A
Self Consumption	3W	3W	5W	5W
MPPT Efficiency	99.5%	99.5%	99.5%	99.5%
Conversion Efficiency	97.5%	97.5%	97.5%	97.5%
Protection	High voltage ,high temperature protection			
<b>Battery Charging</b>				
Battery Type	Sealed ,AGM, Gel, Flooded, Lithium ,User define			
Charging Algorithm	3-stage: Bulk, Absorption, Float, Equalize			
Bulk charge voltage	Sealed:14.4V AGM Gel:14.1V Flooded:14.6V User define:12-14.6V (For 24V system, total voltage*2 . For 48V system, total voltage*4)			
Float charge voltage	Sealed/Gel/AMG:13.7V Flooded:13.6V User define :12-14.6V (For 24V system, total voltage*2 . For 48V system, total voltage*4)			
Temperature compensation	-5mV/℃ with BTS(Optional)			
<b>Communication</b>				
Communication Port	USB			
<b>Mechanical</b>				
Net weight	3KG	3.2KG	3.9KG	4.1KG
Dimensions(mm)	280*180*100	280*180*100	305*200*105	305*200*105
Cooling	Fan cooling			
Enclosure	IP20			
<b>Environment</b>				
Ambient Temperature	-25~60℃ ( Derating from 45℃ )			
Storage Temperature	-40℃~+80℃			
Humidity	100% non-condensing			