

**Solar Pump Inverter
750W-5500W**



Table Of Contents

Information on this Manual	1
Validity.....	1
Scope.....	1
Target Group.....	1
Safety Instructions.....	1
Symbols.....	2
Introduction	3
Solar Pumping System.....	3
Features.....	3
Product Overview.....	4
Installation	4
Unpacking and Inspection.....	4
Mounting the Unit.....	5
Wiring Introduction	6
Terminal Introduction.....	6
Assemble DC Connector.....	7
Assemble AC Output Connector.....	7
Assemble AC Input Connector.....	9
Wiring of Water Level Sensor.....	10
Recommended Diameter of Wire.....	11
Operation	12
Display Panel.....	12
LCD Display Information.....	13
Parameters Setting.....	14
1. Work Mode Setting.....	14
2. Conduct parameter setting for the motor.....	15
Function Parameters	18
Troubleshooting	19
Specifications	20

Information on this Manual

Validity

This manual is valid for the following devices:

- ▶ Single phase 220V solar pump inverter, 750W~4000W
SPI 750TL-G2, SPI 1500TL-G2, SPI 2200TL-G2, SPI 4000TL-G2
- ▶ Three phase 220V solar pump inverter, 750W~4000W
SPI 750TL-LV, SPI 1500TL-LV, SPI 2200TL-LV, SPI 4000TL-LV
- ▶ Three phase 380V solar pump inverter, 2200W~5500W
SPI 2200TL-HV, SPI 4000TL-HV, SPI 5500TL-HV

Scope

This manual describes the assembly, installation, operation and troubleshooting of this unit. Please read this manual carefully before installations and operations.

Target Group

This document is intended for qualified persons and end users. Tasks that do not require any particular qualification can also be performed by end users. Qualified persons must have the following skills:

- ▶ Knowledge of how a pump inverter works and is operated
- ▶ Training in how to deal with the dangers and risks associated with installing and using electrical devices and installations
- ▶ Training in the installation and commissioning of electrical devices and installations
- ▶ Knowledge of the applicable standards and directives
- ▶ Knowledge of and compliance with this document and all safety information

Safety Instructions

WARNING: This chapter contains important safety and operating instructions. Read and keep this manual for future reference.

Inspection



If missing components or damaged inverter is found after receiving, please do NOT install or operate it. Otherwise, it may cause human injury or equipment damage.

Installation



1. Before installation, please make sure if the voltage range of PV panel meets the requirement.
2. Check if all wires are firmly connected without short circuit. Otherwise, it will cause equipment damage.
3. Do NOT install this inverter under direct sunlight because high temperature may cause equipment damage.
4. Please install the inverter away from inflammable and explosive objectives. Please ensure no liquid can enter the inverter.
5. Please install the inverter on metal non-combustible surface.



1. **CAUTION!!** Only qualified personnel can install and operate this inverter.
2. To reduce risk of electric shock, disconnect power source before making wire connection. Otherwise, it may cause electrical shock.
3. To reduce risk of electric shock, NEVER touch any terminals on electric circuits.
4. If connection cable between inverter and water pump is more than 50m, please be sure to install a three-phase AC reactor. Inductance value for each phase is about 1mH. Otherwise, water pump would be easily to be damaged.

Operation



1. Only after wire connection is complete and put cover back to the inverter, it's Enter to do commissioning. Otherwise, it will cause electric shock
2. If sunlight is sufficient but little water is pumped, maybe the wires on motor connection are reversely connected. Please reverse any two wires of them.
3. When testing water pump, be sure to install water pump at appropriate water level. Never allow water pump in dry running. Otherwise, the inverter will activate protection.

Maintenance



1. Only qualified personnel can maintain, repair, inspect the inverter and replace any components.
2. It may still contain energy after disconnecting power source within 5 minutes. Only service after the bus voltage is within safe range.

Symbols

	Grounding Wire of Equipment
	AC Value
	DC Value
	Phase
	Before operating inverter, please read the instruction.
	In order to avoid electric shock, break off machine with PV terminal and AC terminal for at least 5 minutes, then contact the wire of machine output terminal and input terminal
	Warning: when machine works, the temperature of metal shell may be very high.

Introduction

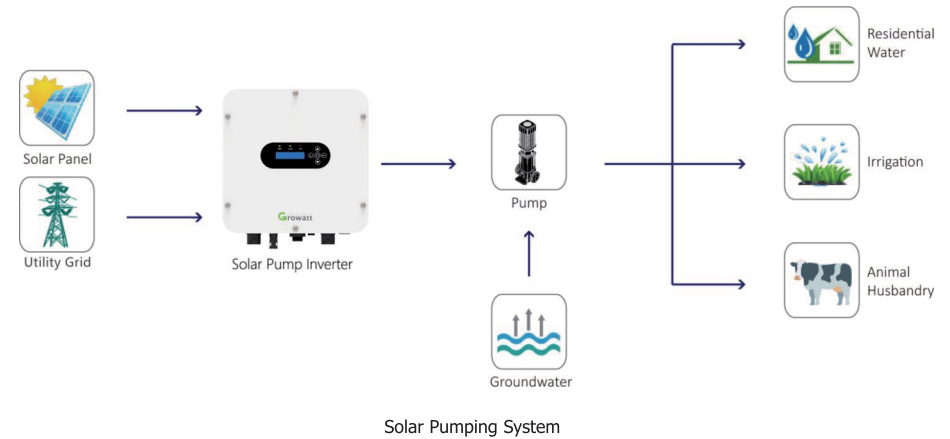

This is a solar pump inverter which allows power to be switched from the AC/DC power obtained from solar panels and grid to the AC power needed to control the pump.

This series solar pump inverters are built-in with Boost circuit for MPPT solar charger to maximize solar power, and able to set the priority of PV and utility grid input. The inverter is suitable for submersible pumps, ground pumps, swimming pool pumps and other pumps using three phase asynchronous motors.

Features

- ▶ Rated power 750W to 5500W
- ▶ Inbuilt MPPT solar controller
- ▶ Inbuilt BOOST circuit for broaden PV voltage range
- ▶ Automatic selection of photovoltaic and AC power
- ▶ IP65 protection level
- ▶ Built-in full protection and self-diagnosis
- ▶ Soft start function
- ▶ Comprehensive LCD and LEDs display real-time system status
- ▶ Remote monitoring through GPRS /4G (optional)

Product Overview

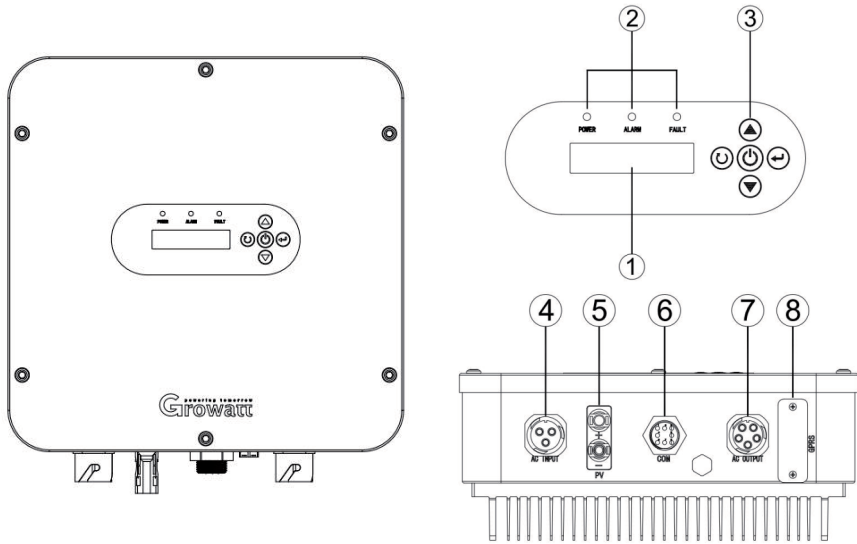

1. LCD display
2. LED indicators
3. Function buttons
4. AC input
5. PV input
6. Water level sensor port
7. AC output
8. GPRS communication port(optional)

Installation

Unpacking and Inspection

Before installation, please inspect the unit. Be sure that nothing inside the package is damaged. You should have received the following items inside of package:

- ☞ The unit x 1
- ☞ User manual x 1
- ☞ Attachment x 1

Mounting the Unit

Consider the following points before selecting where to install:

- ☞ Do not mount the inverter on flammable construction materials.
- ☞ Mount on a solid metal surface.
- ☞ Avoid direct sunlight. Be sure the environment is shady and cool.
- ☞ Be sure to install the inverter into a box with waterproof and dustproof.
- ☞ Install this inverter at eye level in order to allow the LCD display to be read at all times.
- ☞ The recommended installation position is to be adhered to the wall vertically.
- ☞ Be sure to keep other objects and surfaces as shown in the diagram to guarantee sufficient heat dissipation and to have enough space for removing wires.

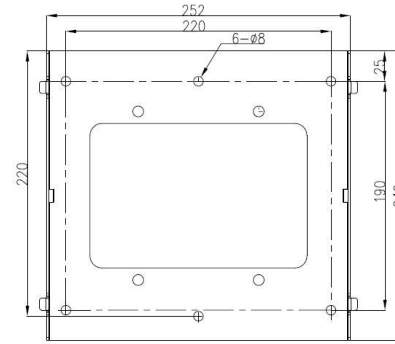
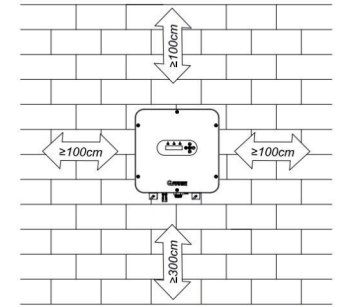

Single phase 220V 750w-2.2kw
3 phase 220V 750w-2.2kw

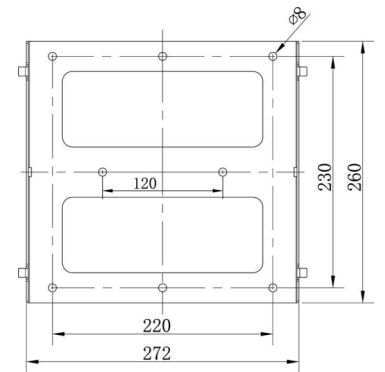

Single phase 220V 4kw
3 phase 380V 2.2kw-5.5kw



SUITABLE FOR MOUNTING ON CONCRETE OR OTHER NON-COMBUSTIBLE SURFACE ONLY.

Install Safety Nut

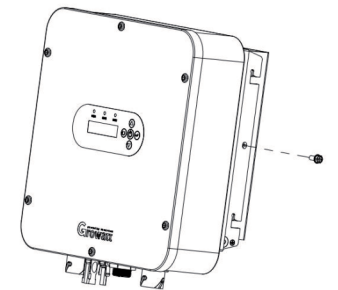
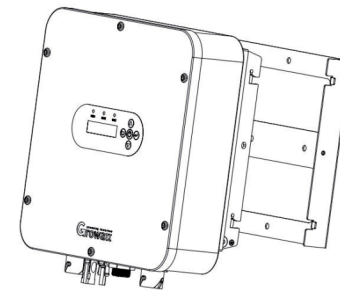

Wiring Introduction

There is AC input, DC input, water level sensor connection terminal, GPRS (optional), and AC output terminal.

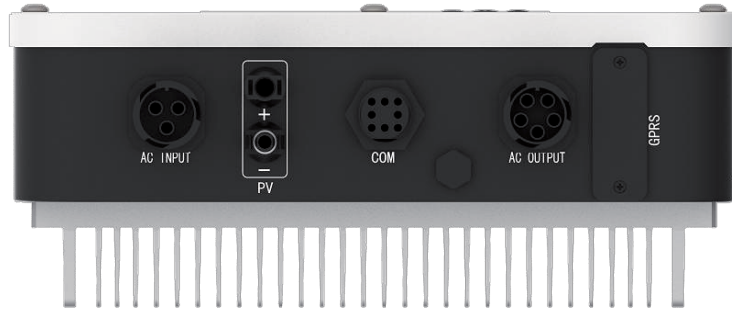

Terminal Introduction

Socket	Terminal Introduction	Wiring Introduction
PV	PV+	Connect with the positive pole of solar array
	PV-	Connect with the negative pole of solar array
AC Input	L	Connect with power grid L phase
	N	Connect with power grid N phase
	PE	Connect with protective ground wire
AC Output (3 PH motor connect 1. 2. L) (1 PH motor connect 1. L)	1	Connect with motor U phase
	2	Connect with motor V phase
	L	Connect with motor W phase
	PE	Connect with protective ground wire
COM terminal	1	Connect with Sensor 2 of water tank
	2	Connect with Sensor 2 of water tank
	3	Connect with Sensor 1 of water well
	4	Connect with Sensor 1 of water well
	5	/
	6	/
GPRS connection terminal	1	+5V
	2	TXD-232
	3	RXD-232
	4	GND

Warning: The places of input sockets of DC positive pole and negative pole of different models are different.

Warning: The signal marshalling sequence of AC output sockets of different models are different.

Assemble DC Connector

Strip the cable 6-8mm, then connect the bare wire core into core tube of connector.



Crimp contact barrel by using a hex crimping die. Put the contact barrel with striped cable in the corresponding crimping notch and crimp the contact. Insert the core tube into slot of connection until hear the sound indicating fit in place.

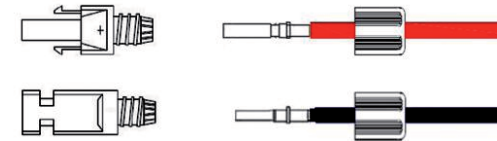

Tighten the nuts to finish the wiring.

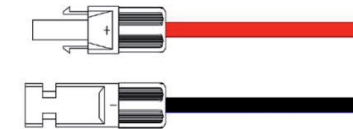

Warning: Risk of electric shock! Before shifting solar panel, disconnect the pump inverter AC and DC. Besides, allow 5-minute internal capacitance discharging.

Assemble AC Output Connector

Connection to the AC output side terminal for Growatt SPI 750-5500TL series solar pump inverter, there are two types of AC connector mode.

For type I of 3 phase AC output connector: AC connector 1,2,L,PE gets connection with the pump through 4 wires (U wire, V wire, W wire and PE wire)

For type II of 1 phase AC output connector: AC connector L, 1, PE gets connection with the pump through 3 wires (L wire, N wire and PE wire)

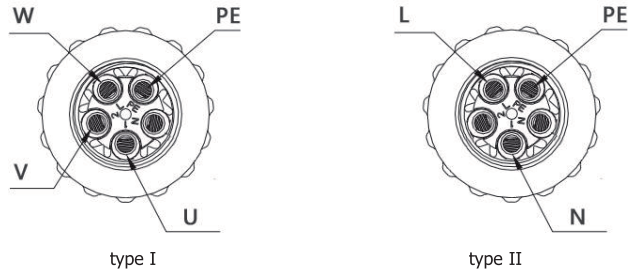

Remove the parts of the AC connection plug from the accessory bag. Guide the pressure screw sealing right, threaded sleeve over the AC cable.

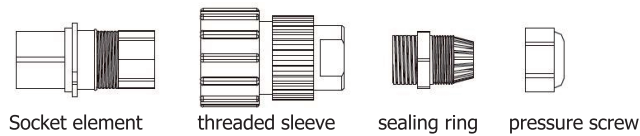

Insert the stripped and bared conductors U, V, W, PE in to screw terminals with sign U, V, W, PE on the socket element and tighten the screws.

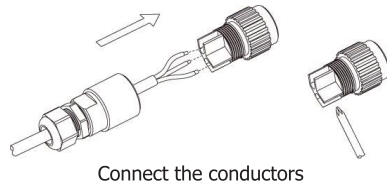

Push the threaded sleeve in to the socket element. Screw the pressure screw tightly onto the threaded sleeve.

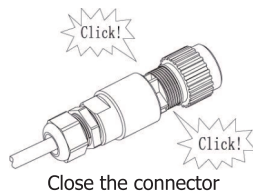

Insert the AC connection plug into the AC connection receptable on the inverter.

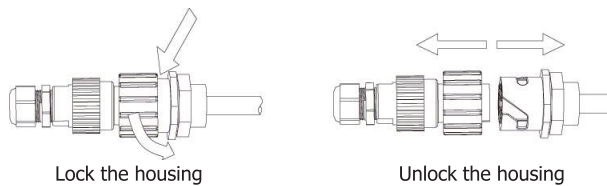

Assemble AC Input Connector

Remove the parts of the AC connection plug from the accessory bag. Guide the pressure screw sealing right, threaded sleeve over the AC cable.

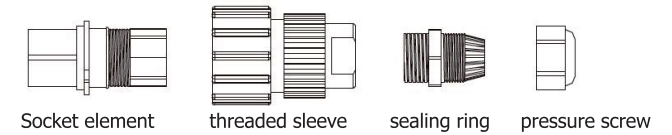

Insert the stripped and bared conductors L, N, PE in to screw terminals with sign L, N, PE on the socket element and tighten the screws.

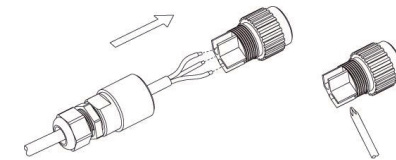

Push the threaded sleeve in to the socket element. Screw the pressure screw tightly onto the threaded sleeve.

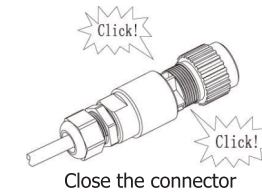

Insert the AC connection plug into the AC connection receptable on the inverter.

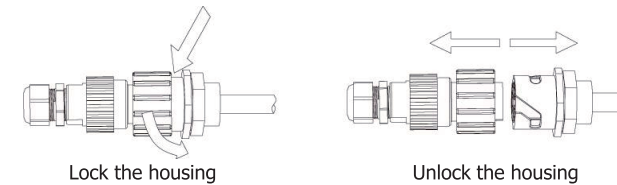

Wiring of Water Level Sensor

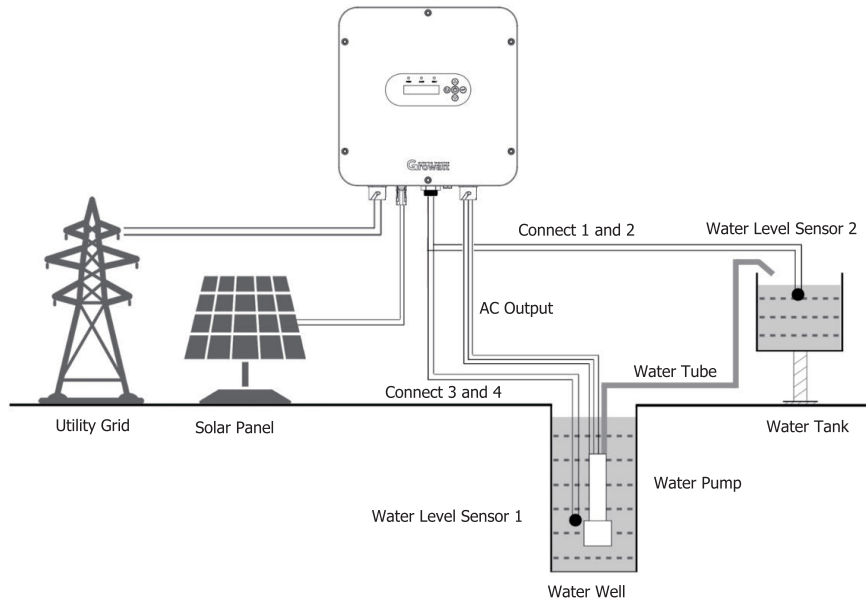

Connection to the COM terminal for Growatt SPI 750-5500TL series solar pump inverter, the water tank connect water level sensor 2, and the water well connect water level sensor 1.

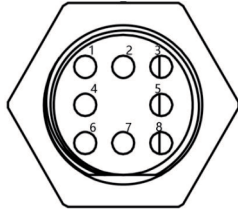

⚠ Notice: connect water level sensor 1 and detect water shortage. Respectively connect two signal lines of sensor with 3 and 4 of COM terminal. When water level sensor 1 detects that the water level of well is lower than the level set by sensor, the pump inverter will delay for 5s, then turn off output protection pump. The water level recovers. Wait for 20s, then the pump inverter re-works normally.

⚠ Notice: connect water level sensor 2 to detect whether water is full. Connect two signal lines of sensor with 1 and 2 of COM terminal. When water level sensor 2 detects that the water level of water tank exceeds the level set by sensor, the pump inverter delays for 5s and turns off output; when water level is lower than set level, wait for 20s, then pump inverter re-starts to work normally.

Recommended Diameter of Wire

Model	Recommended output current(A)	Output voltage(V)	length ≤ 30m	length ≤ 60m	length ≤ 90m	length ≤ 120m	length ≤ 150m	length ≤ 180m	length ≤ 210m
SPI 750TL-G2	5.1	1PH 220V	1	1.5	2.5	4	4	4	6
SPI 1500TL-G2	10.2	1PH 220V	1.5	2.5	2.5	6	6	6	6
SPI 2200TL-G2	14	1PH 220V	2.5	2.5	4	6	6	6	6
SPI 4000TL-G2	25	1PH 220V	2.5	2.5	4	6	6	6	6
SPI 750TL3-LV	4.2	3PH 220V	1	1.5	2.5	4	4	4	4
SPI 1500TL3-LV	7.5	3PH 220V	1.5	2.5	2.5	4	4	6	6
SPI 2200TL3-LV	10	3PH 220V	1.5	2.5	2.5	6	6	6	6
SPI 4000TL3-LV	16	3PH 220V	1.5	2.5	2.5	6	6	6	6
SPI 2200TL3-HV	5.5	3PH 380V	1.5	2.5	2.5	6	6	6	6
SPI 4000TL3-HV	9.5	3PH 380V	1.5	2.5	2.5	6	6	6	6
SPI 5500TL3-HV	14	3PH 380V	2.5	2.5	4	6	6	6	6

Units: mm²



Notice: The environment temperature for the above recommended wire dimension should $\leq 50^{\circ}\text{C}$.



Notice: Large-power wall-mounted model uses multiple-channel DC input. The dimension of DC wire of each channel shall be selected according to the above table.

Operation

Display Panel

Solar pump inverter uses LCD operation panel. The operation panel is shown in the figure, including 3 LED lights, LCD display and 5 keys.

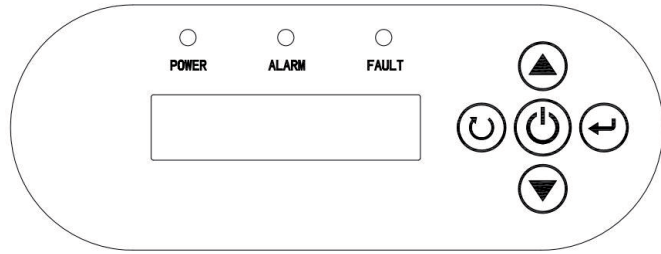

Indicator and Key	Name	Function Introduction	
POWER	System running indicator	Green	LED on, inverter is running
ALARM	Warning indicator	Yellow	LED on, warning or in terminal mode
FAULT	Failure indicator	Red	LED on, system failure
	Operation / Stop Key	1. Press for a short time, then the inverter starts control; 2. Press for 2s, then inverter stops control.	
	Confirm / Programming Key	1. Press for a short time to enter programming mode. After altering parameter, "press for a short time" to confirm the alteration 2. Press for 2s to enter the programming menu.	
	Increment Key	1. When control parameter displays state, increase parameter number or parameter value; 2. When operation displays data state, according to operation mode, increase output frequency or display current operation data.	
	Decrement Key	1. When control parameter displays state, press for a short time to decrease parameter number or parameter value. 2. When operation shows data state, according to operation mode, decrease output frequency or display current operation data.	
	Return Key	Return the initial display	

LCD Display Information



The LCD display information includes operation data, control parameters, and historical parameters. The information on the display will be switched in turns by pressing UP/DOWN key. The selectable information will be switched as below.





Description	Display
Output frequency of the inverter	Running Frequency=50.00Hz Freq Run 50.00Hz
Set frequency of the inverter	Set Frequency=50.00Hz Freq Set 50.00Hz
Input voltage of the inverter	Input PV voltage=548V PV Volt. 548 V
Output voltage of the inverter	Output voltage=379V Output Volt. 379 V
Output current of the inverter	Output current=0.7A Output Curr. 0.7 A
The relative value of rated power	Power capacity=79.1 % Capacity +79.1%

Parameters Setting

1. Work Mode Setting

The inverter includes three work modes: manual work mode, fully-automatic terminal work mode, GPRS work mode (optional). The default mode is fully-automatic terminal work mode.

- Manual work mode: menu P00. Setting P00.01=0. Press  key to operate. Press  key for 2s, then the inverter stop working.
- Fully-automatic terminal work mode: menu P00. Setting P00.01=1. When sunlight is strong enough, the inverter will automatically trace maximum power point.
- GPRS work mode (optional): menu P00. Setting P00.01=2. Under this mode, combined with cellphone number, send messages to set startup, shutdown, parameter inquiry, etc.

Description	Display
Initial status: non-historical data display	
Enter the main parameter modification interface for long press 2s for Enter key 	P00 parameter group, Work Mode group Work Mode P00
Press Enter key  , to enter view the P00.01	P00.01 sub parameter group Work Mode P00.01
Press Enter key  , to enter the P00.01(the factory set is 1)	00.01, value =1 (Default), terminal work mode Work Mode 1
Use Down key  , edite it to 0 (controlled by keyboard)	P00.01, value =0, manual work mode Work Mode 0
Press Enter key  , to save the parameter value and display Set OK!	Present: Set OK! Work Mode Set OK!





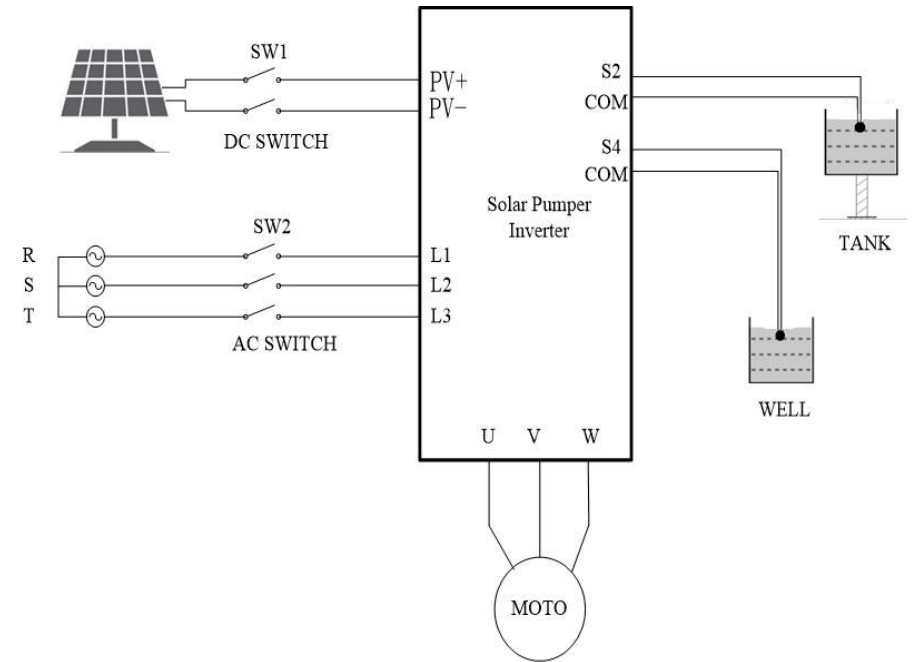









2. Rated parameters setting for the motor









Before setting the parameters, please make sure all the wiring is correct.



- Setting P00.01=0. Command code channel is keyboard manual mode instruction.
- Set water pump nameplate parameters: P02.01 motor rated power value; P02.02 motor rated frequency value; P02.04 motor rated voltage value; P02.05 motor rated current value.
- After finishing parameter setting of water pump, set P00.01=1. The operation code channel is altered as origiiSolar Panel mode instruction.

See as the following figures. (e.g. 5.5KW inverter drives 4.0KW water pump)

Description	Display
Press Enter key  , return to the initial status	Fre ^q Run 50.00Hz
Long press the ON/OFF key  for 2 seconds to stop the inverter	Power off
Enter the main parameter modification interface for long press 2s on Enter key 	P00 parameter group, Work Mode group Work Mode P00
Press the UP key  , to P02 group	P02 parameter group, Rated Parameters group Motor Par. P02
Press Enter key  , to enter the P02.01	P02.01 code channel, Rated Power setting Rating Pwr. P02.01
Press Enter key  , to enter the P02.01 setting Edited value of the rated power	Rated power=5.5KW Rating Pwr. 5.5kW
Use Up/Down key  /  , to edited the rated power to 4.0kW	Rated power=4.0KW Rating Pwr. 4.0kW
Press Enter key  , to save the parameter value and display Set OK!	Present: Set OK! Work Mode Set OK!
Press Enter key  , to enter the P02.01	P02.01 code channel, Rated Power setting Rating Pwr. P02.01
Press UP key  , turn to P02.05	P02.05 code channel, Rated Current setting Rating Curr P02.05
Press Enter key  , to enter the P02.05	Rated Current=10.0A Rating Curr 10.0A
Use Up/Down key  /  , to edited the rated current(it will write in pump) e.g.10.3A	Rated Current=10.3A Rating Curr 10.3A
Press Enter key  , to save the parameter value and display Set OK!	Present: Set OK! Work Mode Set OK!

Press Enter key  , turn to P02.05	P02.05 code channel, Rated Current setting Rating Curr P02.05
Press ESC key  , turn to P02 group	P02 parameter group, Rated Parameters group Motor Par. P02
Press Down key  , turn to P00 group	P00 parameter group, Work Mode group Work Mode P00
Press Enter key  , to enter view the P00.01	P00.01 sub parameter group Work Mode P00.01
Press Enter key  , to enter the P00.01	00.01, value =0, manual work mode Work Mode 0
Press UP key  , edite it to 1	P00.01, value =1, terminal work mode Work Mode 1
Press Enter key  , to save the parameter value and display Set OK!	Present: Set OK! Work Mode Set OK!
Press Enter key  ,return to the initial status	Rated Frequency=50Hz Rating Freq 50.00Hz
Turn off the DC switch and AC switch, waiting the LCD display off, then turn on the DC switch, the inverter will auto-start to drive pump(5.5KW)	

After finishing all parameter settings, turn off DC switch and AC switch. After display screen is OFF for 5 minutes, turn on AC output. Then turn on DC switch and AC switch. Wait for 60s, the machine will operate automatically.



Warning: Do not change parameters at random, otherwise the system might not work normally.

Function Parameters

SN	Name	Scope	Introduction	Default Value
P00.01	Operation code channel	0~2	0: keyboard operation code channel (LED is off) 1: terminal operation code channel (LED flashes) 2: communication operation code channel (LED is solid on)	1
P00.03	MAX.Output frequency	P00.04~400.00	Setting the maximum output frequency	50.00Hz
P00.04	MAX.running frequency	0.00 ~ P00.03	Setting the maximum running frequency	50.00Hz
P00.18	Function restore parameter	0~1	0: No operation 1: Restore the default value	0
P02.01	Rated power of asynchronous motor	0.1 ~ 3000.0	0.1 ~ 3000.0kW	Model confirmation
P02.02	Rated frequency of asynchronous motor	0.01 ~ P00.03	0.01 ~ P00.03	50.00Hz
P02.04	Rated voltage of asynchronous motor	0 ~ 1200	0 ~ 1200V	Model confirmation
P02.05	Rated current of asynchronous motor	0.8 ~ 6000	0.8 ~ 6000A	Model confirmation

Troubleshooting

The inverter has complete protection. When a failure occurs, the inverter will take protective measures. The general protection is to stop the motor from running and forbid it to restart within a certain period.

Code	Description	Possible Reasons	Countermeasures
Power off	No failure	⚡	⚡
Inc OVP Dec OVP Con OVP	Overvoltage	Input voltage is too high	Check the voltage of solar array
Vbus low	Undervoltage	1.Input voltage is too low; 2.Illumination intensity is too weak	Check the voltage of solar array
Inc OCP Dec OCP con OCP	Overcurrent	1.The load of pump is too large; 2.The voltage of solar array is too low; 3.The motor wiring is too long	1.Replace for a smaller pump; 2.Check voltage of solar array; 3.Shorten the wiring between inverter and motor
Overload Tel	Water pump is overload	Load is too large	Decrease maximum operation frequency
Overload VWF	Inverter is overload	The inverter load is too large	Decrease power grade of water pump
IGBT shortcut	Module overcurrent	Output short circuit or grounding module damage	1.Check the wiring 2.Get after-sells support
Inv Overtemp	Module is over-temperature	1.Air flue is blocked 2.Environment temperature is too high 3.The time of overload runing is too long.	1.Clean air flue or improve ventilation 2.Degree the environment temperature
REC Overtemp	Module is over-temperature		
Scarce Phase Out	Output default phase	Equipment or circuit damage	Get after-sells support
Shortcut GND 1	Grounding short circuit	The output line may be connected with ground	Check the wiring
Curr Test Fault	Current detection failure	1.The control board connection is in poor contact 2.The hall component is damaged The magnifying circuit is abnormal	Get after-sells support
Lack load	Water pump conducts "dry-operation"	Water pump's connection wires are all open circuit. Water pump does not match inverter	1.Check water level. 2.Check whether the water pump wiring condition and water pump power meet the requirements of inverter capacity
No Water	Water shortage	Water shortage warning	When water is provided, it can recover automatically
Water Full	Water full	Water full warning	When water level decreases, it can recover automatically
Com Fault	Communication failure	Device or circuit damage	Reset Get after-sells support



Warning: Try to find out the failure reason before your try reset. If it can't reset or suffers failure again after reset, please try find out the reason first. Continuously resetting could damage the inverter.

Specifications

MODE	SPI 750TL -G2	SPI 1500TL -G2	SPI 2200TL -G2	SPI 4000TL -G2	SPI 750TL3 -LV	SPI 1500TL3 -LV	SPI 2200TL3 -LV	SPI 4000TL3 -LV	SPI 2200TL3 -HV	SPI 4000T3 -HV	SPI 5500TL3 -HV	
DC INPUT												
Max.DC voltage	450V				450V				800V			
Starting voltage	80V				80V				220V			
Recommended MPPT voltage	100~400V				100~400V				220~750V			
Max. DC current	9A	12A	12A	20A	9A	12A	12A	20A	12A	20A	20A	
Number of input channels	1	1	1	2	1	1	1	2	2	2	2	
AC INPUT												
Input voltage	1PH 220~240V (-15%~+10%)				1PH 220~240V (-15%~+10%)				3PH 380V (-15%~+10%)			
Rated input current	9.5A	16A	24A	38A	9.5A	16A	24A	38A	6A	14A	20A	
Input frequency	47~63 Hz											
AC input terminal	L,N, PE				L,N, PE				R,S,T,PE			
AC OUTPUT												
Rated output power	750W	1500W	2200W	4000W	750W	1500W	2200W	4000W	2200W	4000W	5500W	
Rated output current	5.1A	10.2A	14A	25A	4.2A	7.5A	10A	16A	5.5A	9.5A	14A	
Output wiring mode	1P1L				3P3L				3P3L			
Output voltage	0~220V				0~220V				0~380V			
Output frequency	0~50/60Hz											
CONTROL PERFORMANCE												
Control mode	V/F											
Motor type	Asynchronous motor (1PH 220V)				Asynchronous motor (3PH 220V)				Asynchronous motor (3PH 380V)			
PROTECTION FUNCTIONS												
Output overcurrent	YES											
Output overload	YES											
Output short-circuit	YES											
Dry/Overflow protection	YES											
OTHERS												
Display	LCD											
Communication	GPRS/WIFI (OPTION)											
Certificate Standard	CE											
Dimensions (W×D×H), mm	370×335×135			450×365×150	370×335×135			450×365×150				
Net weight, kg	9.5			16.5	9.5			16.5				
Operation temperature range	-25~60°C (with derating above 45°C)											
Environmental Protection Rating	IP65											
Cooling	Natural cooling											
Altitude	3000m (with derating above 2000m)											
Relative humidity	0~100%											